

Juggler

user manual

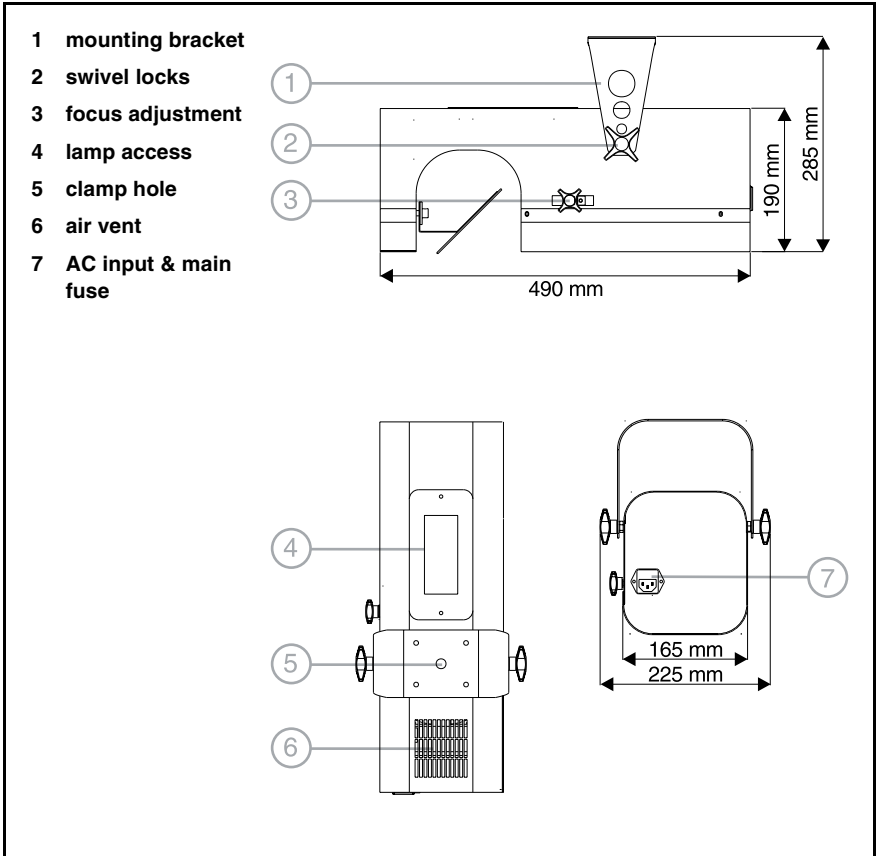



Thank you for selecting the Martin Juggler. This lighting fixture uses a 250 watt halogen lamp, a moving mirror, an 18-position color/gobo wheel, and a built-in microphone to project exciting effects automatically in time with the music.

UNPACKING

The packing material is carefully designed to protect the fixture during shipment - always use it to transport the fixture.

The Juggler comes with:

- 500 hour halogen lamp (installed)
- mounting bracket
- 1.5-meter, 3-wire IEC power cable
- user manual

SAFETY PRECAUTIONS

The Juggler is not for household use. It is not a toy: it presents risks of serious injury due to electric shock, high heat, and intense light. For safe operation, read this manual before using the fixture and observe all warnings and precautions printed here and on the fixture. If you have questions about how to operate the fixture safely, please contact your Martin distributor or dealer.

- **For protection against dangerous electric shock, always ground (earth) the fixture electrically. Use only a source of AC power that complies with local building and electrical codes.**
- **Replace the lamp if it becomes defective or worn out. Allow the fixture to cool for 5 minutes before installing a new lamp.**
- **Keep all combustible materials (for example fabric, wood, paper) at least 30 cm (12 inches) away from the fixture. Keep flammable materials well away from the fixture.**
- **Provide a minimum clearance of 10 cm (4 inches) around the fan and air vent.**
- **When suspending the fixture above ground level, verify that the structure can hold at least 10 times the weight of all installed devices and secure the fixture with an approved safety cable. Block access below the work area whenever installing or removing the fixture.**
- **Never remove any cover except the lamp access cover. Refer all service to a qualified technician.**
- **Do not expose the fixture to rain or moisture.**
- **Do not illuminate surfaces within 1 m (39 inches) of the fixture.**
- **Do not operate the fixture if the ambient temperature exceeds 40° C (104° F).**
- **NEVER place filters or other objects over the lens or mirror.**

SETUP

LAMP INSTALLATION

The Juggler is shipped with a Philips 24V/250W ELC 500 hour halogen lamp installed. When replacing the lamp, use only one of the compatible lamps listed on page 10. *Installing any other lamp may damage the fixture!*

Allow the lamp to cool for at least 5 minutes before moving the fixture. To avoid possible damage, remove the lamp when shipping the fixture.

Warning! *Disconnect the fixture from AC power and allow the fixture to cool for 5 minutes before installing a new lamp.*

To install a lamp in the Juggler

- 1 Disconnect the fixture from AC power. If replacing a lamp, allow it to cool for 5 minutes before removing the lamp access cover. The lamp cools faster with the cover in place.
- 2 Remove both screws from the lamp access cover and lift the cover off.
- 3 Grasp the old lamp by the reflector and pull it out of the holder. Then pull the socket off the lamp. Do not pull the wires.
- 4 Push the socket fully onto the pins of the new lamp.
- 5 Gently push the lamp into the holder until it snaps into place.
- 6 Replace the lamp access cover and screws.

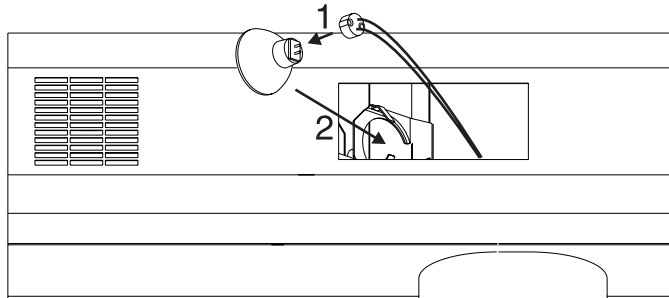

AC POWER CONNECTION

The fixture's mains lead may require a grounding-type cord cap that fits your power distribution cable or outlet. Consult a qualified electrician if you have any doubts about proper installation.

Warning! For protection from dangerous electric shock, the fixture must be grounded (earthed). The AC mains supply shall be fitted with a fuse or circuit breaker and ground-fault protection.

- Following the cord cap manufacturer’s instructions, connect the yellow and green wire to ground (earth), the brown wire to live, and the blue wire to neutral. The table below shows some pin identification schemes.

Wire	Pin	Marking	Screw color
brown	live	“L”	yellow or brass
blue	neutral	“N”	silver
yellow/green	ground		green

INSTALLATION

The Juggler can be permanently installed or hung with a clamp (not included), or it can be placed on the floor as described below. For maximum lamp life, do not place the fixture directly on or beside a speaker cabinet or other source of strong vibrations.

Once the Juggler is installed and connected, the focus may be adjusted by loosening and sliding the focus adjustment knob.

Warning! Block access below the work area before proceeding. Always use a secure means of secondary attachment.

To install or hang the Juggler

- 1 Install the mounting bracket on the chassis as shown. Place the washers on the stud before the bracket.
- 2 Verify that the structure can support at least 10 times the weight of all installed fixtures, clamps, cables, auxiliary equipment, etc.
- 3 If hanging the fixture with a rigging clamp, verify that the clamp is undamaged and can bear at least 10 times the fixture’s weight. Bolt the clamp securely to the bracket with a grade 8.8 (minimum) M12 bolt and lock nut, or as recommended by the clamp manufacturer, through the clamp hole in the mounting bracket.

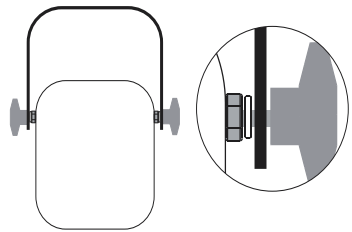

- 4 If permanently installing the fixture, verify that the hardware (not included) and mounting surface can bear at least 10 times the fixture's weight. The four 6 mm holes and the clamp hole in the mounting bracket may be used for attachment.
- 5 Working from a stable platform, clamp or fasten the fixture to the structure.
- 6 Install a safety cable that can hold at least 10 times the weight of the fixture through/over the support and mounting bracket as shown.
- 7 Loosen the swivel locks, tilt the fixture to the desired angle, and retighten.
- 8 Verify that the fixture is at least 0.3 meters (12 in.) from the surface to be illuminated and at least 0.1 meters (4 in.) from any combustible materials. Verify that the clearance around the air vent and lamp access plate is at least 0.1 meters (4 in.).

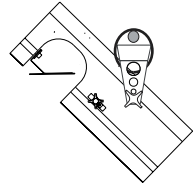

Rigging clamp not shown!

To use the bracket as a floor stand

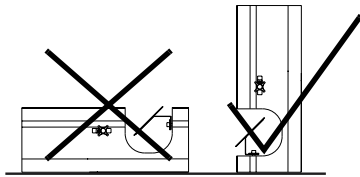

The Juggler may be placed on the floor by standing it squarely on the mirror end or with the support of the mounting bracket. *Never lay the fixture flat on its back!*

- 1 (Optional) Install the mounting bracket as described above.
- 2 Set the fixture flat on its mirror end or in one of the positions shown below. Adjust the mounting bracket and tighten both swivel locks.
- 3 Verify (1) that the fixture is stable, (2) that the fixture is at least 0.3 meters (12 in.) from the surface to be illuminated and at least 0.1 meters (4 in.) from any combustible materials, and (3) that the clearance around the air vent and lamp access plate is at least 0.1 meters (4 in.).

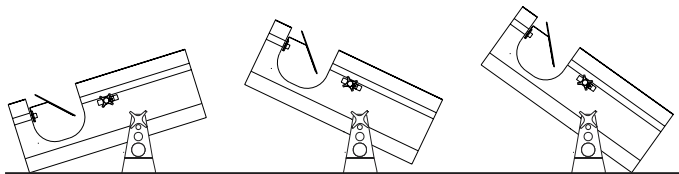

OPERATION

Warning! *Verify that the power cables are undamaged and rated for the current requirements of all connected devices before use.*

Important! *Electric dimmers may damage the electronic components.*

The Juggler's operating voltage is printed on the serial number label near the AC input. Verify that the operating voltage closely matches the AC supply voltage before applying power. Contact your Martin dealer if the voltage on the label differs from the AC mains voltage by more than five percent.

The lamp turns on as soon as power is applied. The effects start moving as soon as sound is picked up by the built-in microphone. An Automatic Gain Control (AGC) adjusts sensitivity when the average sound pressure alters.

Note: Although the Juggler cannot be dimmed, it may be switched on and off remotely using switch packs or the full-on and full-off levels on dimmer packs.

SERVICE

There are no user-serviceable parts inside the Juggler. Please refer all service to a Martin distributor, dealer, or service center.

To replace the main fuse

- 1 **Unplug the mains cable from the input socket. Pry open the fuse holder and remove the fuse.**
- 2 **Replace the fuse with one of the same type. The fuse rating is listed on serial number label.**

TROUBLESHOOTING

problem	probable cause(s)	suggested remedy
No light	No power to the fixture	Check connections
	Blown fuse	Replace fuse
	Burned out lamp	Install new lamp
	Fixture overheating	Allow to cool Improve air flow around fixture
No action	Sound too low to activate control circuit	Increase volume Move speakers closer
	Electrical malfunction	Refer to service technician
Fuse blows repeatedly	Electrical malfunction	Refer to service technician

If these remedies do not solve the problem, contact your Martin dealer for service.

SPECIFICATIONS

- Size (L x W x H) 490 x 165 x 190 mm (19.3 x 6.5 x 7.5 in)
- Weight 7.5 kg (16.5 lbs)
- Maximum ambient temperature (T_a).....40° C (104° F)
- Maximum surface temperature60° C (140° F)
- AC input..... 3-prong IEC male socket
- Maximum power and current..... 270 W, 1.2 A @ 230 V
- Primary fuse, EU version.....2.5 AT / 250 V, P/N 05020010
- Primary fuse, US version5.0 AT / 250 V, P/N 05020018
- Minimum distance to combustibile materials 0.3 m (12 in)
- Minimum distance to illuminated surfaces 1.0 m (39 in)
- Minimum clearance around fan and air vents 0.1 m (4 in)

ACCESSORIES

- Martin DMX Switch Pack, 210-245 V 90758200
- Martin DMX Switch Pack, 100-130 V 90758300
- Osram 24V/250W ELC 50 h halogen lamp 97000104
- Philips 24V/250W ELC 500 h halogen lamp..... 97000107
- G-clamp 91602003
- Half-coupler clamp 91602005

