

Operating Instructions

Sound Reinforcement &
Recording Consoles

WR-S4412
WR-S4416
WR-S4424

RAMSA

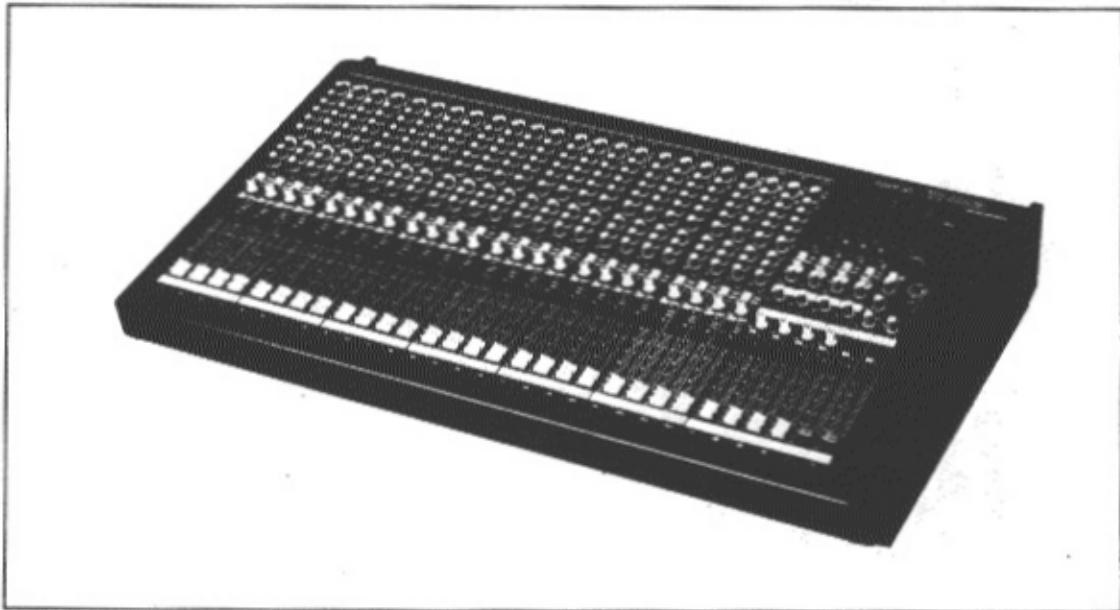

Panasonic[®]

Before attempting to connect or operate this product, please read these instructions completely.

CONTENTS

GENERAL	2
FEATURES	2
PRECAUTIONS	3
MAJOR OPERATING CONTROLS AND THEIR FUNCTIONS	4
IN/OUT CABLE INFORMATIONS	8
BLOCK DIAGRAM	9
SYSTEM APPLICATIONS	10
LEVEL DIAGRAM	13
APPEARANCE	14
TECHNICAL SPECIFICATIONS	17
INPUT SPECIFICATIONS	18
OUTPUT SPECIFICATIONS	18

WARNING

This service literature is designed for experienced repair technicians only and is not designed for use by the general public. It does not contain warnings or cautions to advise non-technical individuals of potential dangers in attempting to service a product. Products powered by electricity should be serviced or repaired only by experienced professional technicians. Any attempt to service or repair the product or products dealt with in this service literature by anyone else could result in serious injury or death.

WARNING:
TO PREVENT FIRE OR SHOCK HAZARD, DO NOT EXPOSE THIS APPLIANCE TO RAIN OR MOISTURE.

GENERAL

The RAMSA WR-S4400 Series Sound Reinforcement and Recording Consoles have been designed and built based on the same quality and technology of RAMSA's high-end professional mixing consoles. These consoles are available in three different sizes: the 12-input WR-S4412, 16-input WR-S4416 and 24-input WR-S4424.

Whether you are mixing sound for a band, school auditorium, theater, A/V production studio, or night club, the RAMSA WR-S4400 Series can enhance the quality of your mix.

FEATURE

Overall

- Each input channel includes an addressable AUX control, which can be switched to feed either a mixing buss or the input channel's Direct Out. This greatly increases output capability, especially in cases where an effect is dedicated to a single input source. The AUX Direct Out function is also useful for feeding the inputs of a Multi Track Recorder.
- The distributed grounding system used in RAMSA mixing consoles reduces hum, crosstalk, and other sound-degrading characteristics to an absolute minimum.
- All channel inputs, Group Outputs, and L/R Master Outputs are electronically balanced.
- The Head Amplifier has a continuously variable trim range of 64 dB, enabling it to accept any Mic or Line source with a nominal level between -60 dB and +4 dB. Proper setting of the input trim control optimizes signal-to-noise ratio and allows approx. 22 dB of headroom between -60 dB and -2 dB at the A-input. (More than 18 dB between +4 dB and -2 dB.)
- The Low Noise Discrete Differential Amplifier on each channel has a maximum input level of 24 dB.
- Phantom Power (48V) is individually switchable on each input channel. Its noiseless operation prevents potentially damaging switching noise from reaching the speakers.
- A new high-precision long-stroke carbon fader has been developed for the WR-S4400 Series mixers.
- The frame is a very sturdy semi-monocoque design, able to withstand the demands of transporting.
- The width of each channel strip is only 29 mm, the minimum possible while still accomodating XLR connectors. The result is more channels in a smaller frame, which improves portability.

Input Section

- The input circuit of this module consists of switchable dual universal Mic/Line input connectors. A switch selects either the "A" input (XLR connector) or "B" input (TRS Phone Plug); both of which are electronically balanced. Gain structuring of the head amplifier permits the "A" input to accept any signal with a nominal level between -60 dB and +4 dB ("A" input), or -54 dB and +10 dB ("B" input). Sensitivity is infinitely variable by the Input Level Control.
- Buss assign switches allow easy signal routing to the 4 Group Output Busses and the L-R Master Busses.
- The Pan control "positions" the signal within the stereo field by adjusting the relative level between signals sent to the Left and Right Master Busses; and also for odd/even panning between Groups 1/2, 3/4.
- Phantom power (48 V) is switched on or off for each individual channel ("A" input only) by the 48 V Phantom Power Switch.
- Three-band equalization is provided on each input channel.

High : Shelving \pm 15 dB, 12.5 KHz fixed
Mid : Peak/dip \pm 15 dB, 200 Hz-6.3 KHz sweepable
Low : Shelving \pm 15 dB, 70 Hz fixed

There are 4 AUX busses per input channel. The AUX 1 and AUX 2 signal takeoff point is fixed either pre- or post-fader, selectable by internal jumpers. AUX 3 and AUX 4 are selectable pre- or post-fader by a front panel switch on each channel. Internal jumpers located on each circuit board permit selection of pre- or post-EQ.

NOTE :

JUMPER MODIFICATIONS MUST BE PERFORMED BY AUTHORIZED SERVICE PERSONNEL.

- The DIR Out switch routes the AUX 1 signal to either the channel Direct Output, or to the AUX 1 mixing buss.
- Each input channel has red and green LED level indicators. When the signal level to the Head Amplifier reaches a level approx. 8 dB below nominal, the green lamp lights. The red lamp turns on when the level is within 8 dB of clipping.
- PFL (pre-fader listen) is provided on all input channels. This allows an individual channel or group of channels to be monitored through the headphones or monitor output.

Output Section

- The output module consists of Group 1-4 outputs, AUX 1-4 outputs, Master L/R outputs, 4 stereo AUX Returns, Monitor and Headphone outputs, L/R Record outputs, and talkback function.
- 12-point LED bar-graph meters (peak meters) display level for all busses, including PFL.
 - (1) Group 1/AUX 1
 - (2) Group 2/AUX 2
 - (3) Group 3/AUX 3
 - (4) Group 4/AUX 4
 - (5) Left Master
 - (6) Right Master/PFL
- Bar-graphs 1-4 have switches to select metering of either Group or AUX out. Bargraph 6 automatically switches over to PFL any time a PFL button is pressed. An LED indicates in red when PFL is active and being displayed by the meter.
- Pre Fader Listening (PFL) Switches are provided for each Master, Group, and AUX bus.
- Insertion and Sub-inputs are provided for Groups 1-4 and L/R Master outputs.
- A Talk Back Microphone Connector is provided, which accepts input signals between -50 dB and -20 dB. The Talk Back Signal can be routed to the Master, Group, and AUX outputs by assign switches.

PRECAUTIONS

Read the following section carefully to insure safe and proper use of the mixer.

NEVER INSERT OR REMOVE MODULES FROM THE CHASSIS WHEN THE POWER IS TURNED ON. BE SURE TO TURN THE POWER OFF OR DAMAGE TO THE MIXER WILL RESULT.

1. A 48 volt potential exists between pins 2 and 1 and between pins 3 and 1 of the input XLR connectors when phantom power is turned on.
2. Turn on the phantom power switch only after a connector has been inserted into that channel in order to prevent shocks and avoid damaging clicking and popping sounds. When disconnecting phantom microphones, wait at least 20 sec. after turning phantom power off. When disconnecting the microphone, set the channel on switches to OFF position and faders to $-\infty$.
3. Be especially careful to keep the phantom switch turned off when using an unbalanced type microphone or when any other type equipment is connected the input connectors. Failure to do so may result in damage, smoke, or fire.
4. When using the input selector switch while the phantom power is turned on, turn the output fader down to avoid any popping noise which might damage the speakers or other equipment connected to the mixer.
5. The phantom power supply employs a slow start system to avoid click sounds from being produced. Allow 1 minute after pressing phantom power switch for voltage to stabilize.
6. Set all faders to minimum and channel switches off when turning the power on and off.
7. Avoid using the mixer near anything that generates electric fields, such as transformers, lighting, transmitters, CRT monitor etc.

MAJOR OPERATING CONTROLS AND THEIR FUNCTIONS

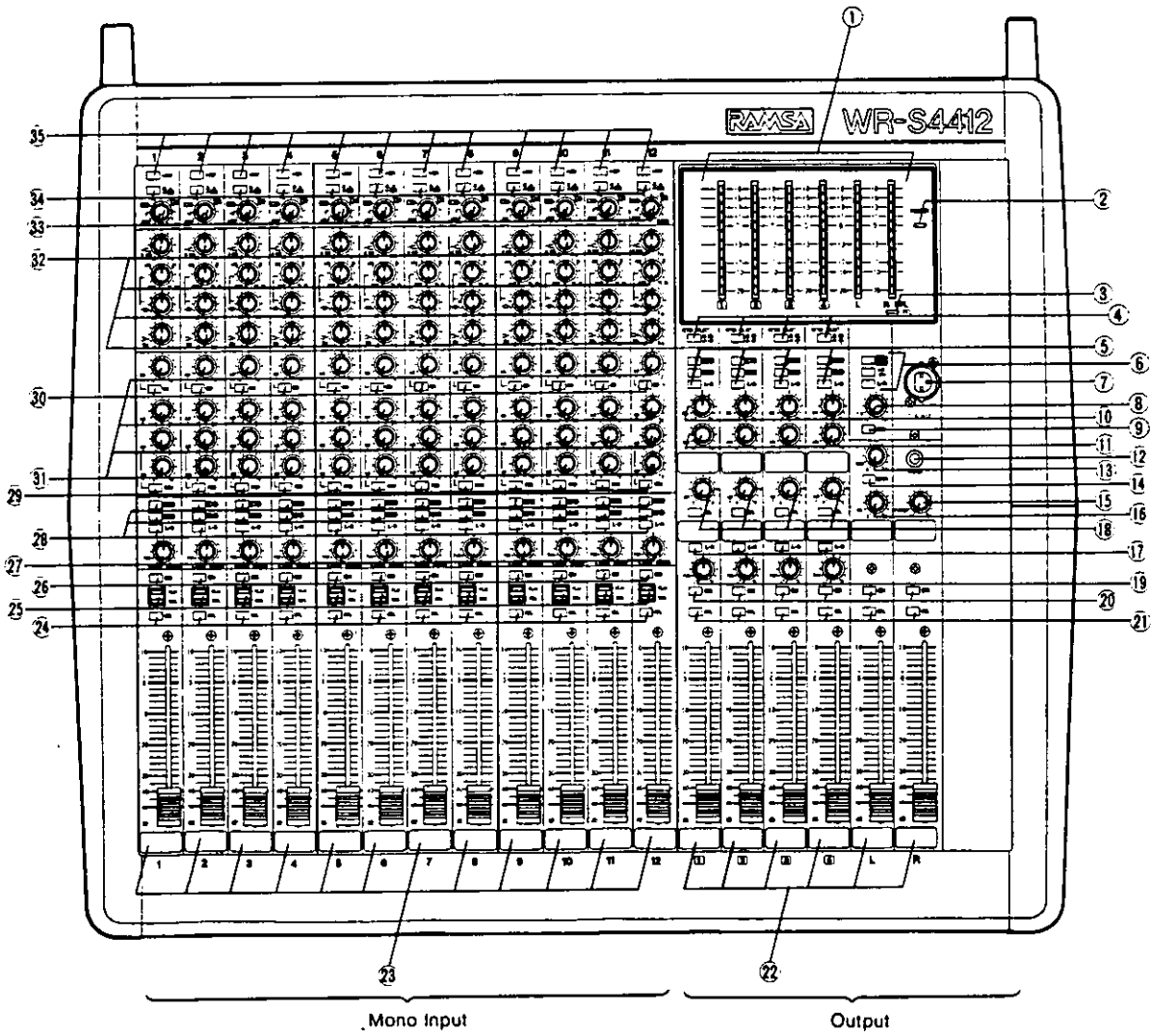
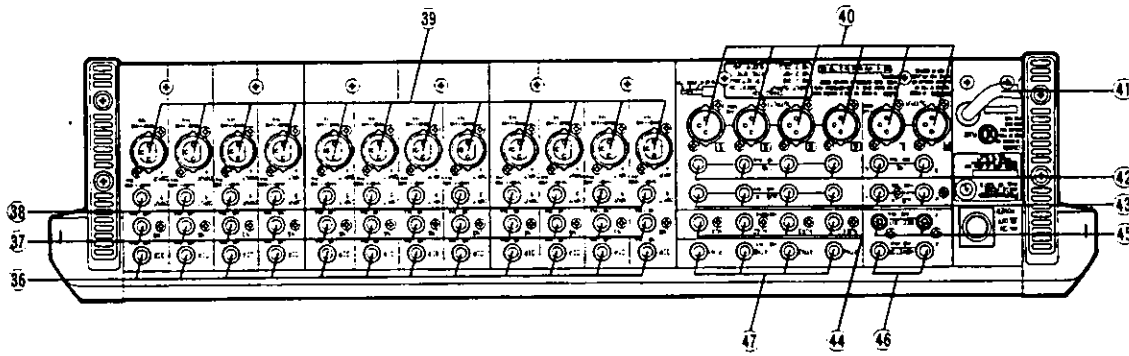

1. **12-point LED Bar-graph Meters (1/2/3/4/L/R)**
These LED peak reading meters are designed to have quick attack time to monitor transients and slow decay time for optimum visual indication. There are 3 color ranges, along with dB graduations relative to nominal level: Green for -20 dB to 0 dB, Yellow for +1 dB to +5 dB, Red for +8 dB or more.
 - 1: This meter displays Group 1 output level or AUX 1 output level.
 - 2: This meter displays Group 2 output level or AUX 2 output level.
 - 3: This meter displays Group 3 output level or AUX 3 output level.
 - 4: This meter displays Group 4 output level or AUX 4 output level.

L:

This meter displays Left Master output level.

R/PFL:

This meter displays Right Master output level or PFL level. Meters 1-4 are switch selectable. The R/PFL meter is automatically switched any time a PFL button is pressed.
2. **Power Indicator LED**
This LED lights when the Power Switch is turned on.
3. **PFL Indicator LED (R/PFL)**
This LED lights when any PFL Switch is turned on. The R/PFL 12-point LED bar-graph meter displays PFL signal level when this LED is lit.
4. **Meter Selection Switches (METER SELECT, 1/2/3/4)**
These switches are used to select either Group or AUX bus signals to be displayed by the 12-point LED bar-graph meters 1-4.
Pressing the switch down selects the AUX signal. The up position selects Group.
5. **AUX Return Assign Switches**
These switches route the stereo AUX Return signals to the group and master busses. The left input signal can be sent to Group 1, Group 3, and L Master. The right input signal can be sent to Group 2, Group 4, and R Master.
For more information regarding connection of AUX Return signals, see number 3-1 on page 8, "AUX Return Input Jacks".
6. **Talk Back Assign Switches**
These route the signal input via the TB Mic connector. The talk back signal is assignable to all group, master, and AUX busses.
7. **Talk Back Microphone Connector (T.B MIC)**
This XLR female connector is used for the connection of a talk back microphone.
8. **Talk Back Level Control**
This is a dual-function control to simultaneously adjust the talk back input sensitivity and the output level of the talk back signal.
9. **Talk Back ON/OFF Switch (ON)**
This is a push-push type switch. The Talkback function is active while the switch is held in the down position.
10. **Balance Controls (BAL, L-R)**
These controls set the balance between the Left and Right AUX RTN input signals.
11. **AUX Return Input Controls (RTN 1/2/3/4, 0-10)**
These controls set the level of Stereo AUX Return input signal to be sent to the assigned busses.
12. **Phone Jack (PHONES)**
1/4" TRS phone jack for headphone.
Maximum output is 160 mW / 400 ohms.
13. **Monitor Master Level Control (MONI, 0-10)**
This control adjusts the level of the monitor outputs. The takeoff point for the monitor signal is either L/R Master or PFL. When any PFL button is depressed, it takes priority over the L/R Master for being sent to the Monitor and Headphone Outputs. Therefore, any buss can be monitored, as well as any input channel.
14. **Mono Monitor Switch (MONO)**
Pressing this switch down to the mono position combines the left and right monitor into a mono signal, then sends it to the left and right Monitor outputs.
15. **Headphone Level Control (PHONES, 0-10)**
This control is used to set the headphone level. The signal sent to the headphone output is the same as the one being sent to the monitor outputs (L/R Master or PFL).
16. **PFL Control (PFL 0-10)**
This control adjusts the level of the PFL signal present at the monitor outputs and headphone outputs. Proper setting of this control avoids variances in level when switching between Master and PFL mode.
17. **Group L-R Send Switches (L-R)**
When these switches are turned on, the Group signal is sent to the L/R Master busses. This is useful for creating a submix.
18. **AUX 1-4 Master Level Controls (AUX, 0-10)**
These controls adjust the overall level of each AUX output signal.
19. **Group Pan Pot Controls (PAN, L-R)**
These controls are used to adjust the left/right balance of the Group signal sent to the Master L and R channels via the L/R Send switches.
20. **Channel On Switches (ON)**
These are the on/off switches for the Group and Master Outputs.
21. **Pre Fader Listening Switches (PFL)**
These switches may be pressed to send any of the Group, AUX, or Master busses to the Monitor and Headphone Outputs. The PFL signal takes priority over the L/R Master monitor signal.

22. Output Faders

These high precision type 100 mm carbon faders are used to adjust the Group and Master output level. Position 0 represents the nominal output level.

23. Input Faders

These high precision type 100 mm carbon faders are used to control the level of input channels signal being sent to the mixing busses. Fader should be at "0" for obtaining nominal level.

24. Pre Fader Listening Switches (PFL)

These switches may be pressed to send individual input channel or mixing buss signal to the Monitor and Headphone outputs. Multiple PFL buttons may be turned on to monitor any combination of signals. The PFL signal takes priority over the L/R Master monitor signal, which is present at the Monitor and Headphone outputs when all PFL buttons are off.

25. Signal Indicator LED (PEAK/SIGNAL)

These LEDs indicate input head amplifier signal status. These light green when the signal reaches a level approximately 8 dB below nominal, and turn red when the signal is within 8 dB of clipping level. In case of a consistent red indication, the input level control (INPUT) should be turned to counterclockwise.

26. Channel On Switches (ON)

The input signal sent to the Master, Group, and AUX mixing busses is passed (on) or muted (off) by these switches.

27. Pan Pot Controls (PAN, L/1/3,R/2/4)

These controls divide the input signal into separate left and right, and sets the relative level (balance) between them.

This mixer has odd/even group panning, which means that Groups 1/2 and Groups 3/4 are set up as stereo pairs. Therefore, panning left will cause signals to be sent to L Master, Group 1, and Group 3. Panning right will send the signals to R Master, Group 2, and Group 4.

28. Program Bus Assign Switches (1/2, 3/4, L-R)

Input signals may be sent to Groups 1-4 and L-R Master Busses by means of these switches.

29. Pre Fader Switches (PRE)

These switches select between a pre- or post-fader takeoff point for the AUX 3 and AUX 4 signals. Pre is normally used for monitoring applications, while post is effective when using AUX 3 and AUX 4 as effects sends.

The pre-fader signal can be set to either pre- or post-EQ by means of internal jumpers.

NOTE:

JUMPER MODIFICATIONS MUST BE PERFORMED BY AUTHORIZED SERVICE PERSONNEL.

30. Direct Out Switches (DIR)

Selects the signal path for AUX 1. When the switch is down, signal is sent from the AUX 1 control to the input channel's Direct Output. The up position routes the AUX 1 signal to the AUX 1 mixing buss. No signal is present at the channel's Direct Output when this switch is up. Example for use: A particular effect may be needed for only 1 input source. The input source gets routed to the effect via its input channel's Direct Output, while the send level is set by the AUX 1 control. Without this function, the master AUX 1 output would have to be connected to that effect. AUX 1 could then not be used on any other input channel, since the effect was intended for use with only the one input source. In other words, the number of effects sends available is not limited by the 4 AUX busses.

31. AUX Level Controls (AUX 0-10)

These set the signal level being sent to each of the AUX mixing busses (and Direct Out in the case of AUX 1).

32. Equalizer

Three-band equalizer :

The high and low bands are a shelving type with cutoff frequencies of 12.5 kHz and 70 Hz respectively. The mid band is a peaking type with a continuously variable frequency range of 200 Hz - 6.3 kHz.

High : ± 15 dB (± 12 dB at 12.5 kHz) Shelving

Mid : ± 15 dB (200 Hz to 6.3 kHz) Peak/dip

Low : ± 15 dB (± 12 dB at 70 Hz) Shelving

33. Input Level Controls (INPUT)

These controls set the sensitivity of the A and B universal mic/line inputs.

Proper setting of these controls provides optimum signal-to-noise ratio and approx. 22 dB of headroom between -2 dB and -60 dB at A-input. (More than 18 dB between $+4$ dB and -2 dB.) The A input nominal level range is -60 dB to $+4$ dB. The B input nominal level range is -54 dB to $+10$ dB.

34. Input Selector Switches

These switches are used for selecting either the A (XLR) Input or B (1/4" TRS Phone) Input.

Both A Input and B Input are electronically balanced.

35. 48V Phantom Power Switches (+48V)

These are ON/OFF switches for 48 volt phantom power, which is used by condenser microphones. Phantom power is supplied only to the A input (XLR) connector.

36. Direct Out Jacks (DIR, -2 dB 10 kohms)

(1/4" Phone Jack, -2 dB, 10 kohms, unbalanced)

Output signal for each input channel. The Direct Out is fed by the AUX 1 control when the DIR switch is pushed in. May be used for effects send, multitrack tape recorder send, etc.

- 37. Insertion Jacks (INS, -2 dB 10 kohms)**
 (1/4" TRS Phone Jacks, -2 dB, 10 kohms, unbalanced)
 A pre-equalizer patch point. Equipment connected to this point becomes, in effect, part of the mixer circuit. Used for signal processors as such as equalizers, compressors, limiters, etc.
 A Y-cord adaptor must be used in order to split this terminal into separate output (Send) and input (Return) connectors. Insertion jack terminals are wired as:
 Tip: Return
 Ring: Send
 Sleeve: Earth
 Insertion points are provided for every input channel - 12(WR-S4412), 16(WR-S4416), 24(WR-S4424).
- 38. 1/4" Phone Input B Jacks**
(INPUT B, -54 dB - +10 dB, 10 kohms)
 These are universal Mic/Line input connectors, which are electronically balanced, configured to accept a 1/4" stereo plug wired as:
 Tip: Hot
 Ring: Cold
 Sleeve: Earth
 When connecting unbalanced equipment to the mixer, use a 1/4" mono plug wired as tip: hot, and sleeve: earth.
 The B input accepts input signals with a nominal level between -54 dB and +10 dB. Input sensitivity is set by the input level control on each channel.
 The number of the 1/4" Phone Input B Jacks are : 12(WR-S4412), 16(WR-S4416), 24(WR-S4424)
- 39. XLR Input A Connectors**
(INPUT A, -60 dB - +4 dB, 5 kohms)
 These are universal Mic/Line XLR input connectors, electronically balanced, and configured as:
 Pin 1: Earth
 Pin 2: Hot
 Pin 3: Cold
 The A input accepts input signals with a nominal level between -60 dB and +4 dB. Input sensitivity is set by the input level control on each channel.
 48 V phantom power is supplied to pins 2 and 3 of the connector when the 48 V switch of that channel is turned on.
 The number of the XLR input connectors are : 12(WR-S4412), 16(WR-S4416), 24(WR-S4424)
- 40. Group and Master Output Connectors**
(1/2/3/4/L/R)
 Output connectors for the Group 1-4 and L-R Master busses (XLR, 600 ohms, +4 dB, electronically balanced).
- 41. AC Power Cord**
- 42. Group and Master Insertion Jacks**
(INS, -2 dB, 10 kohms)
 (1/4" TRS Phone Jack, -2 dB, 10 kohms, Unbalanced)
 Group and Master insertion jacks provide a patch point in the output stages for interconnection of accessory equipment.
 A Y-cord adaptor must be used in order to split this terminal into separate output (Send) and input (Return) connectors. Insertion jack terminals are wired as:
 Tip: Return
 Ring: Send
 Sleeve: Earth
- 43. Sub Input Connectors (SUB IN, +4 dB 10 kohms)**
 (1/4" Phone Jack, +4 dB, 10 kohms, Unbalanced)
 These are inputs which apply signals directly to the Group 1-4 and L-R Master Busses. These may be used for connection of additional mixers, pre-mixed signals, or any other line-level signal.
- 44. AUX Output Connectors**
(AUX 1/2/3/4, +4 dB 600 ohms)
 (1/4" Phone Jack, +4 dB, 600 ohms, Unbalanced)
 Output connectors for the AUX 1-4 Busses.
- 45. Rec Output Jacks**
(REC OUT, R/L, -10 dB 10 kohms)
 (RCA pin jacks, -10 dB, 10 kohms, Unbalanced)
 Master L and R pre-insertion level signals for sending to tape recorder.
- 46. Monitor Output Jacks**
(MONITOR, L/R, +4 dB 10 kohms)
 (1/4" Phone Jack, +4 dB, 10 kohms, Unbalanced)
 These jacks provide a monitor feed of the L/R Master output or PFL signals. PFL has priority over the L/R Master signal.
 This monitor signal is also sent to the Headphone output connector.
- 47. AUX Return Input Jacks**
(RTN 1/2/3/4, +4 dB 10 kohms)
 (1/4" TRS phone jacks, +4 dB, 10 kohms, Unbalanced)
 By using 1/4" stereo jacks, these accept 2 signals on 1 connector to input the returns from a stereo effect or any other stereo line level source (cassette, CD, DAT, etc.).
 Tip = L channel
 Ring = R channel
 Input to the left channel may be sent to Group 1, Group 3, and L Master. Input to the right channel may be sent to Group 2, Group 4, and R Master.
 In case it is desired to send a mono return signal, it is accomplished as follows:
 A. Apply the return signal to either left or right of the AUX Return.
 B. Assign it to a single group bus; for example, Group 1 (press 1/2 assign switch and turn Balance control fully left).
 C. Press the L-R Send switch for Group 1 in. Set the L-R Send Pan control to center detent.
 D. The AUX Return signal will now be sent equally to the left and right master busses.

IN/OUT CABLE INFORMATION

1. XLR Type Connectors

1-1. Balanced Connection (Input)

Connect 2-conductor shielded cable as shown below.

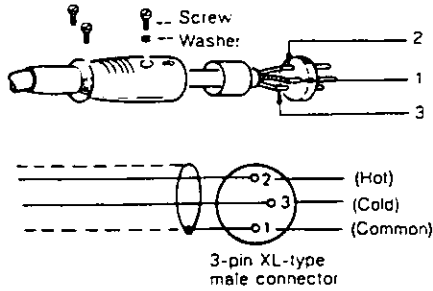

1-2. Balanced Connection (Output)

Connect 2-conductor shielded cable as shown below.

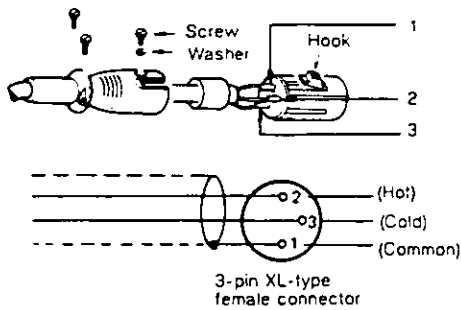

1-3. Unbalanced connection

When connecting unbalanced equipment to the mixer, connect follows : Pin 1 - Common, Pin 2 - Hot, Pin 3 - Common

CAUTION :

Do not connect unbalanced microphones to the mixer when using phantom power. Power supply and microphone may be damaged.

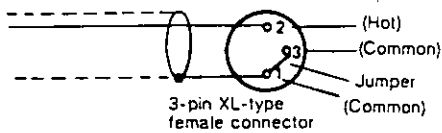

2. 1/4" Tip-sleeve Phone Plug (Input and Output)

Connect single-conductor shielded cable as shown below (Tip - Hot, Sleeve - Common).

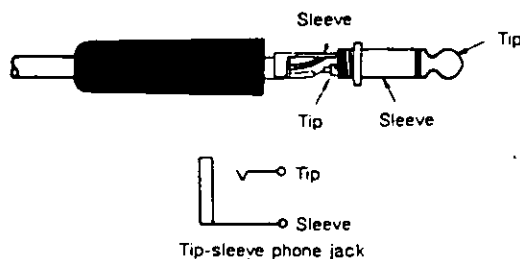

3. 1/4" Tip-ring-sleeve Phone Plug

3-1. AUX Return

Connect 2-conductor shielded cable as shown below.

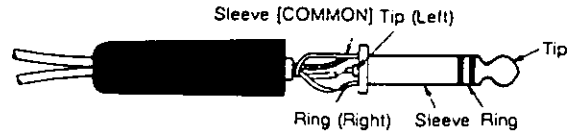

3-2. Input B (Balanced connection)

Connect 2 single-conductor shielded cables as shown below.

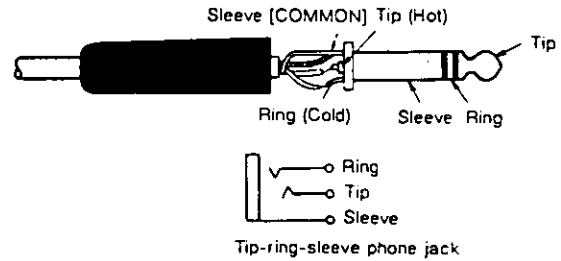

Note :

For unbalanced connection on Input "B", use a single conductor shielded cable with a 1/4" mono plug, as shown in 2.

3-3. Insertion

For insertion at the patch points, use a Y-cord adaptor, wired as tip ; return, ring ; send and sleeve ; common on a 1/4" TRS phone plug.

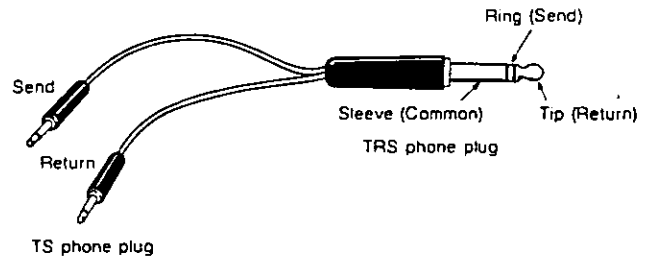

Connect 2 single-conductor shielded cables as shown below. The other end of the shielded cables must have appropriate mating plugs or jacks, or be connected to a patch bay.

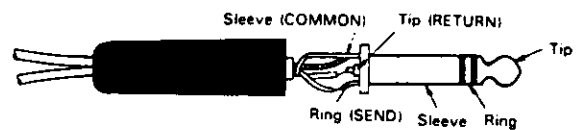

4. RCA Pin-plug Input and Output

Connect single-conductor shielded cable as shown below.

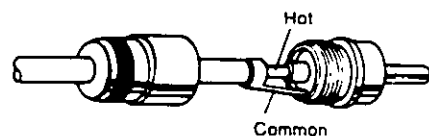

BLOCK DIAGRAM

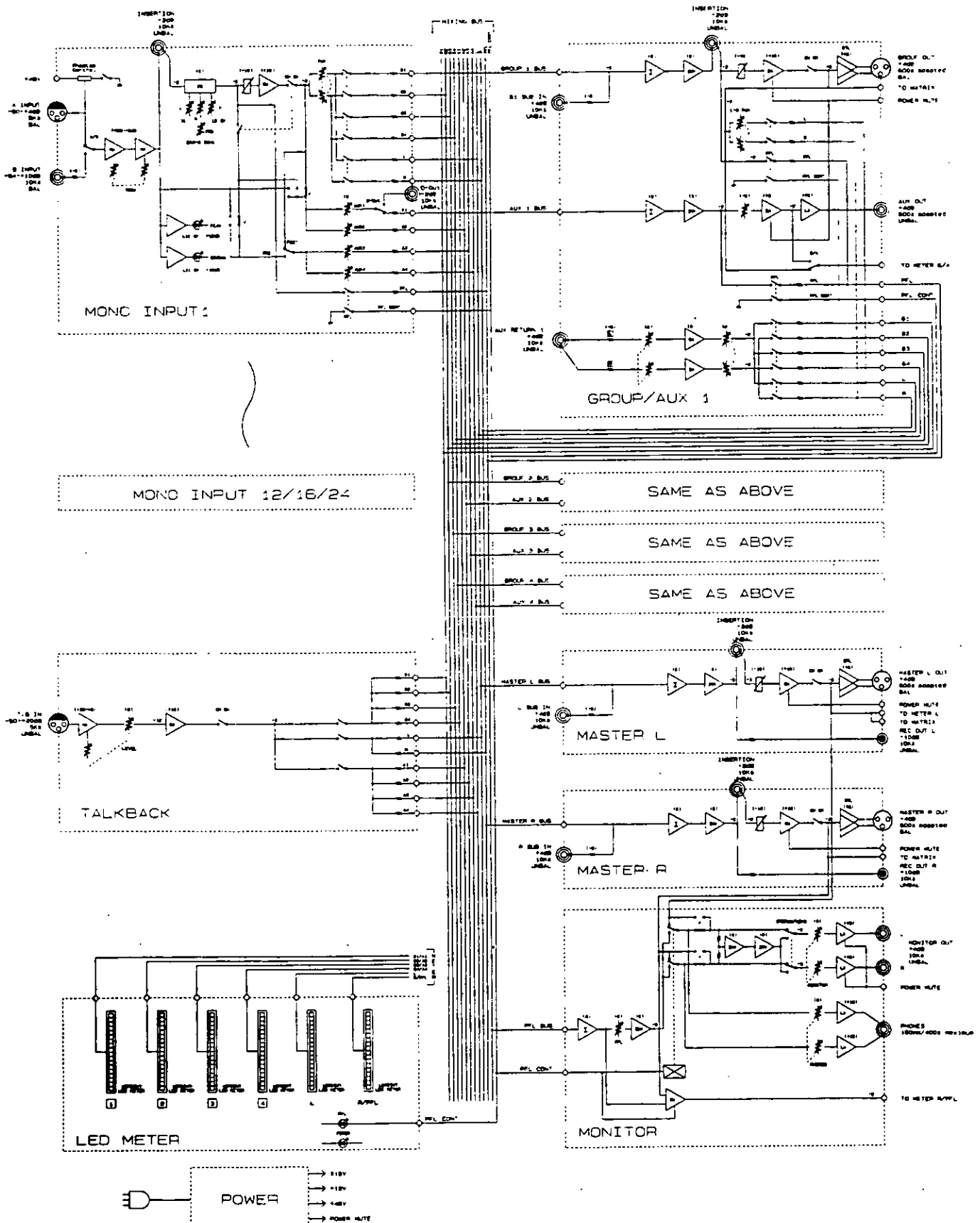

SYSTEM APPLICATIONS

■ FOR STUDIO RECORDING SYSTEM

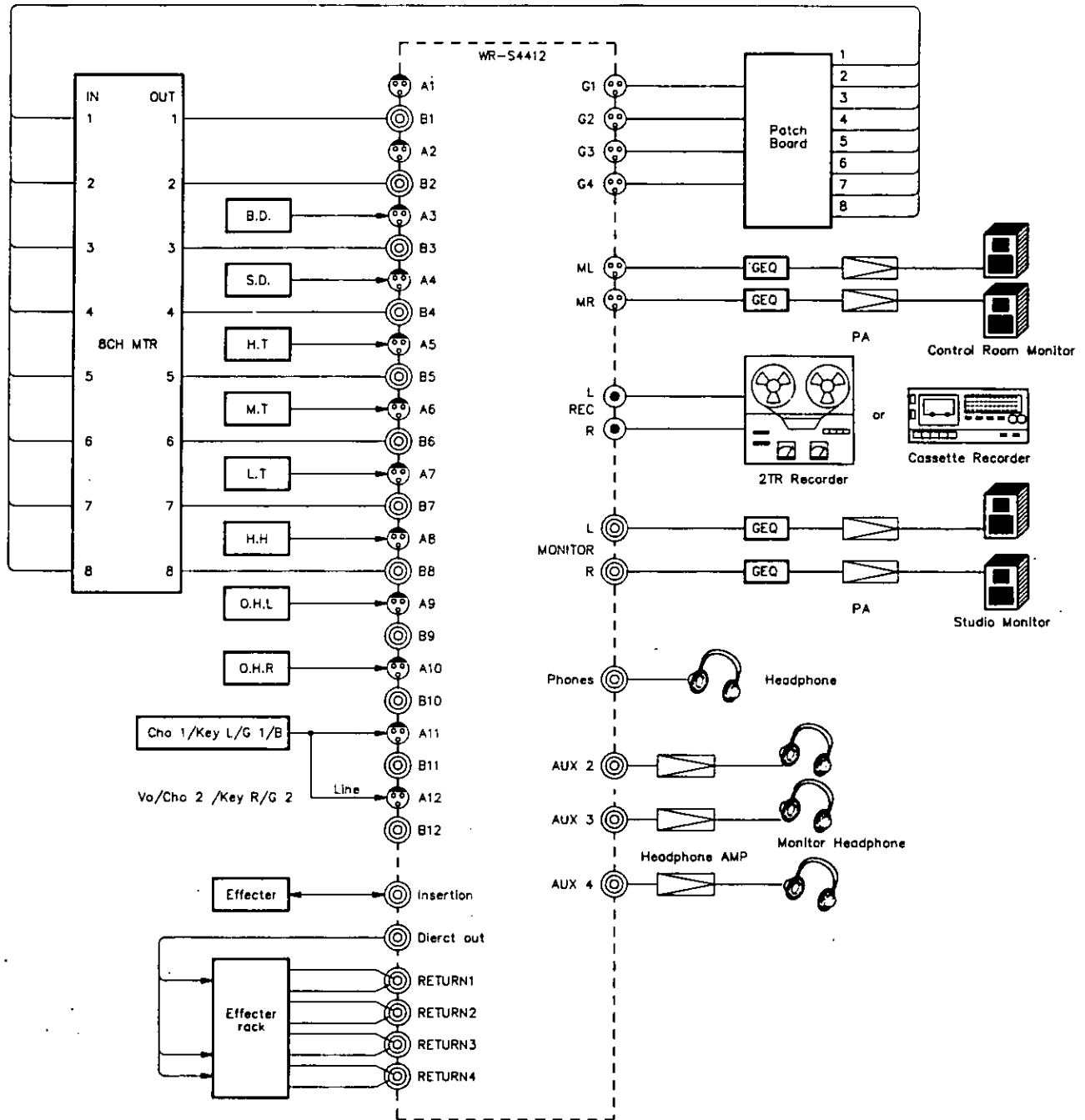

■ FOR LIVE RECORDING SYSTEM

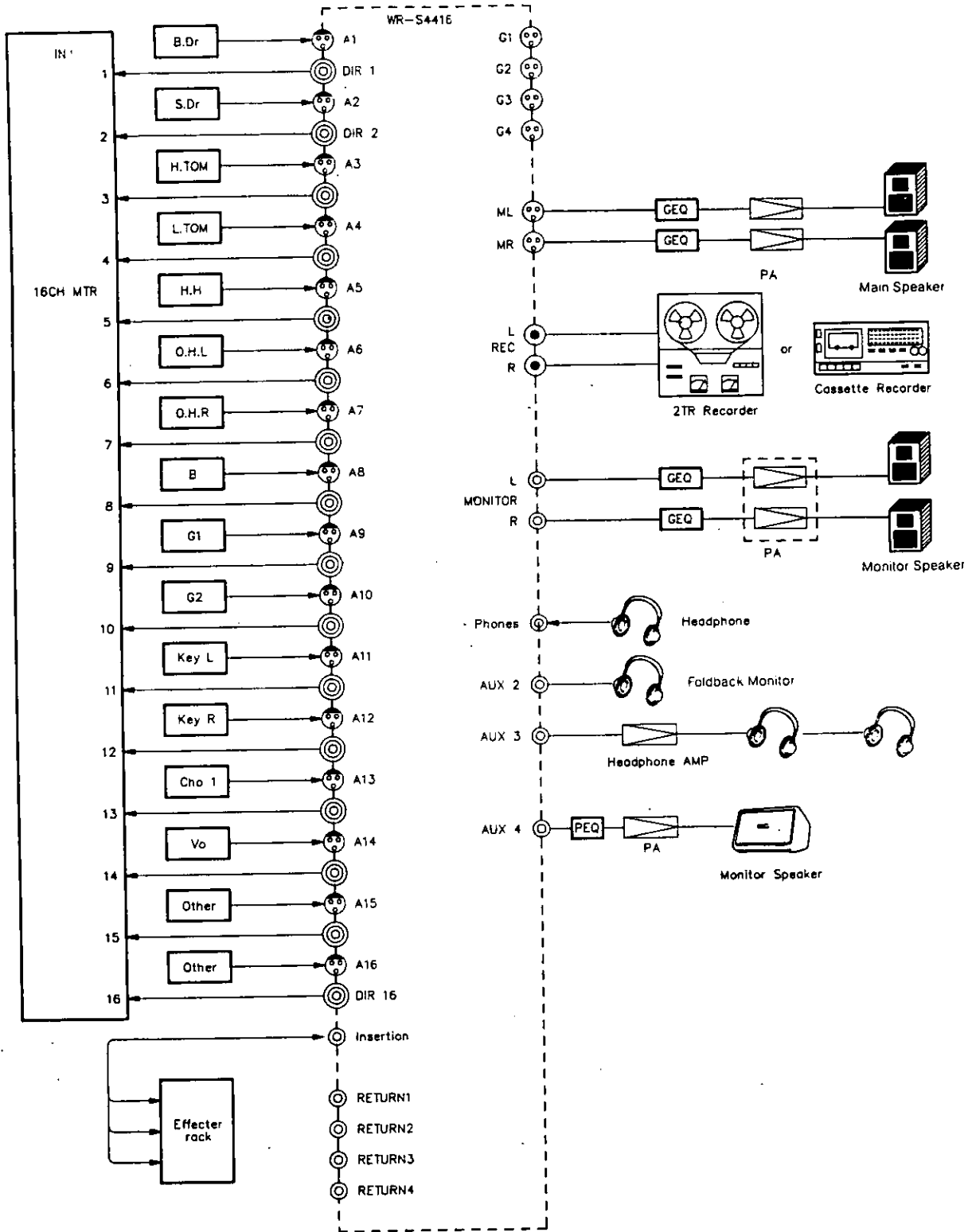

■ FOR LIVE PA SYSTEM

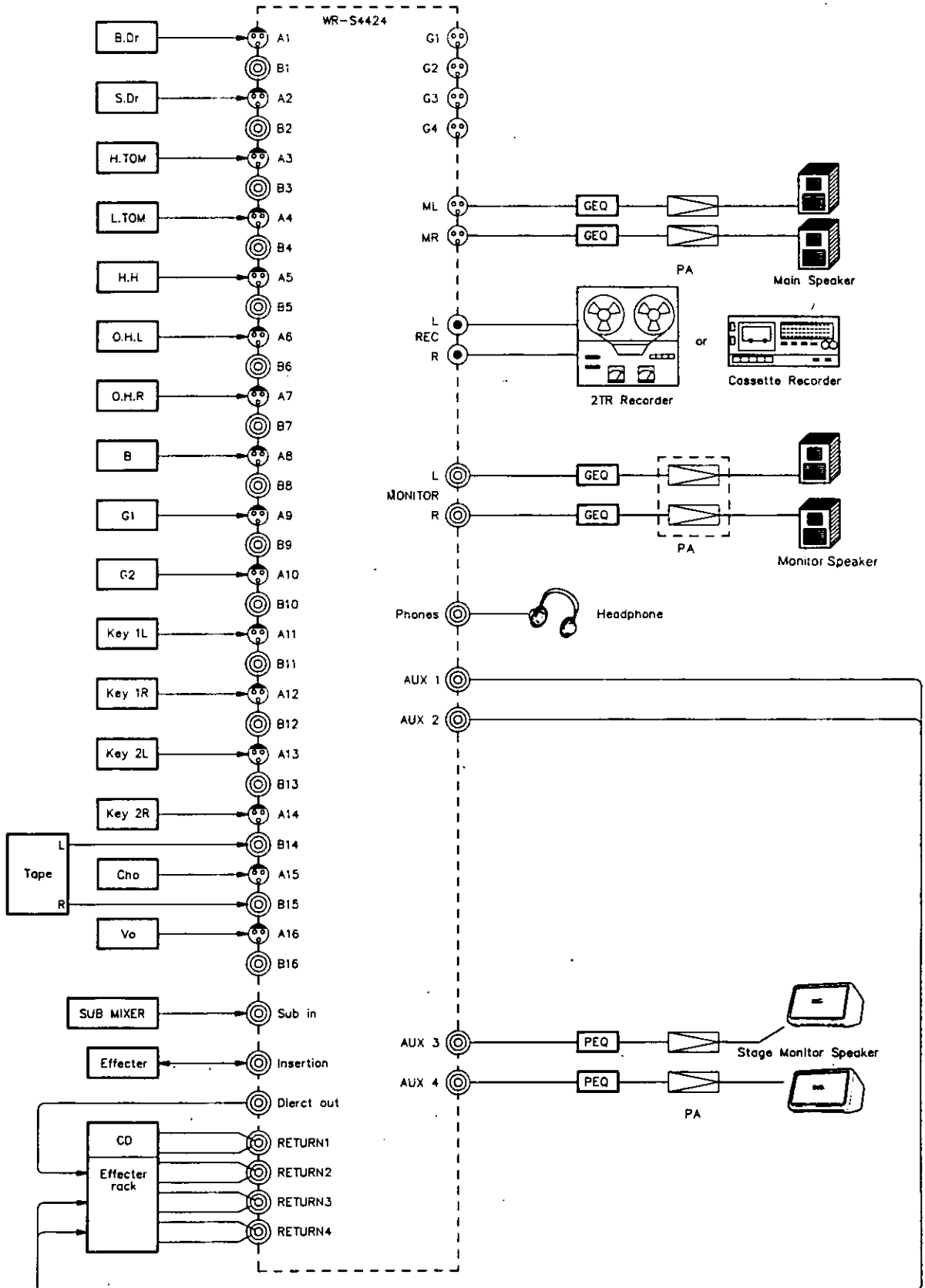

LEVEL DIAGRAM

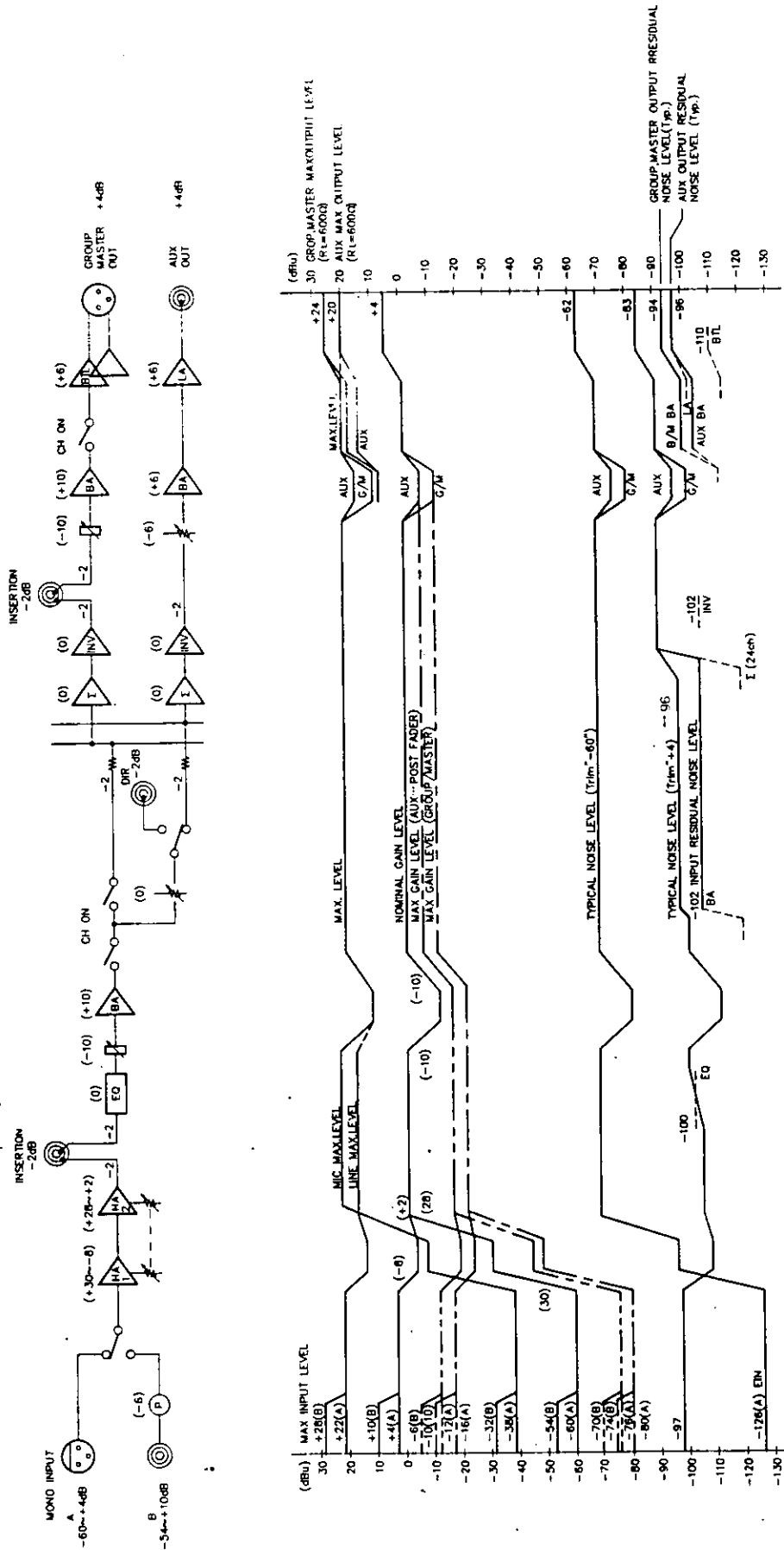

APPEARANCE

Unit : inches (mm)

■ WR-S4412

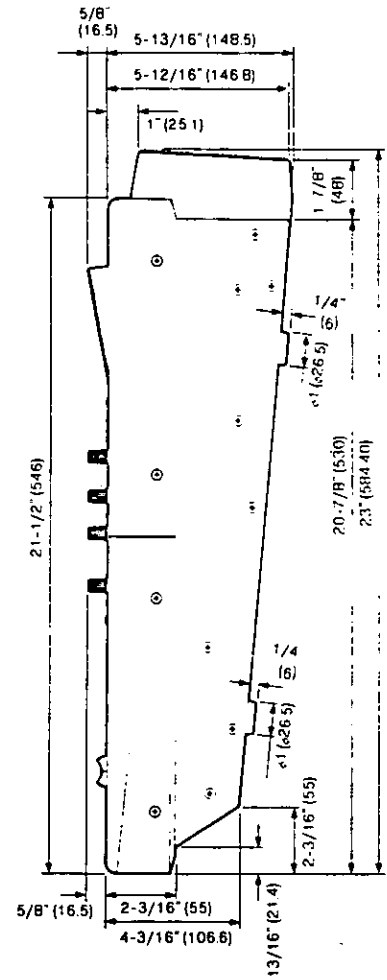
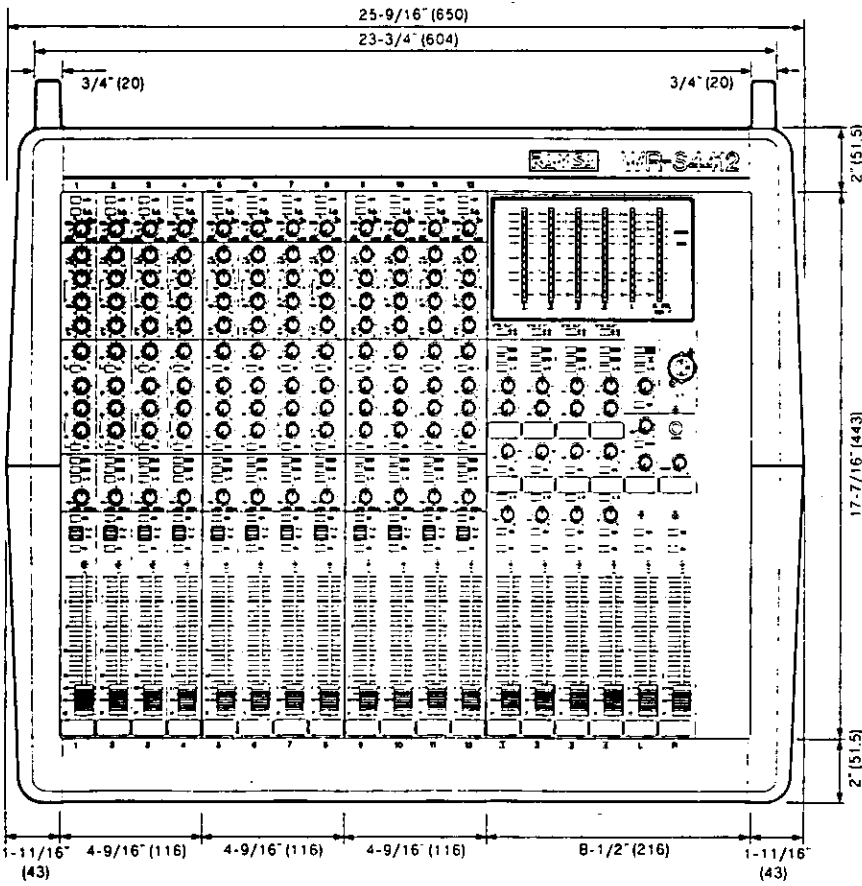
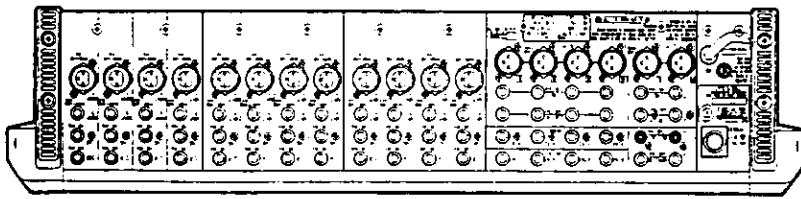

■ WR-S4416

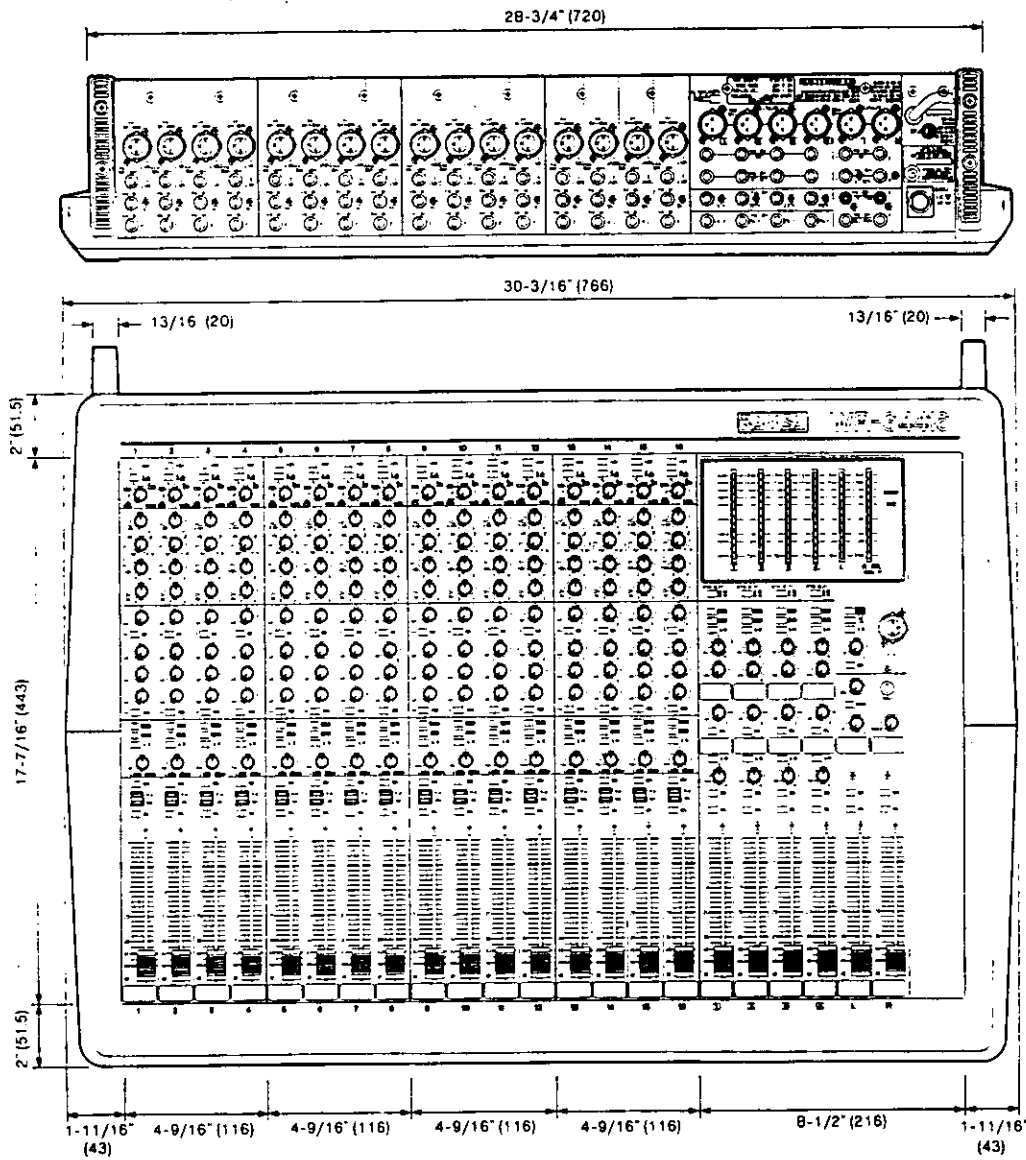

■ WR-S4424

Unit : inches (mm)

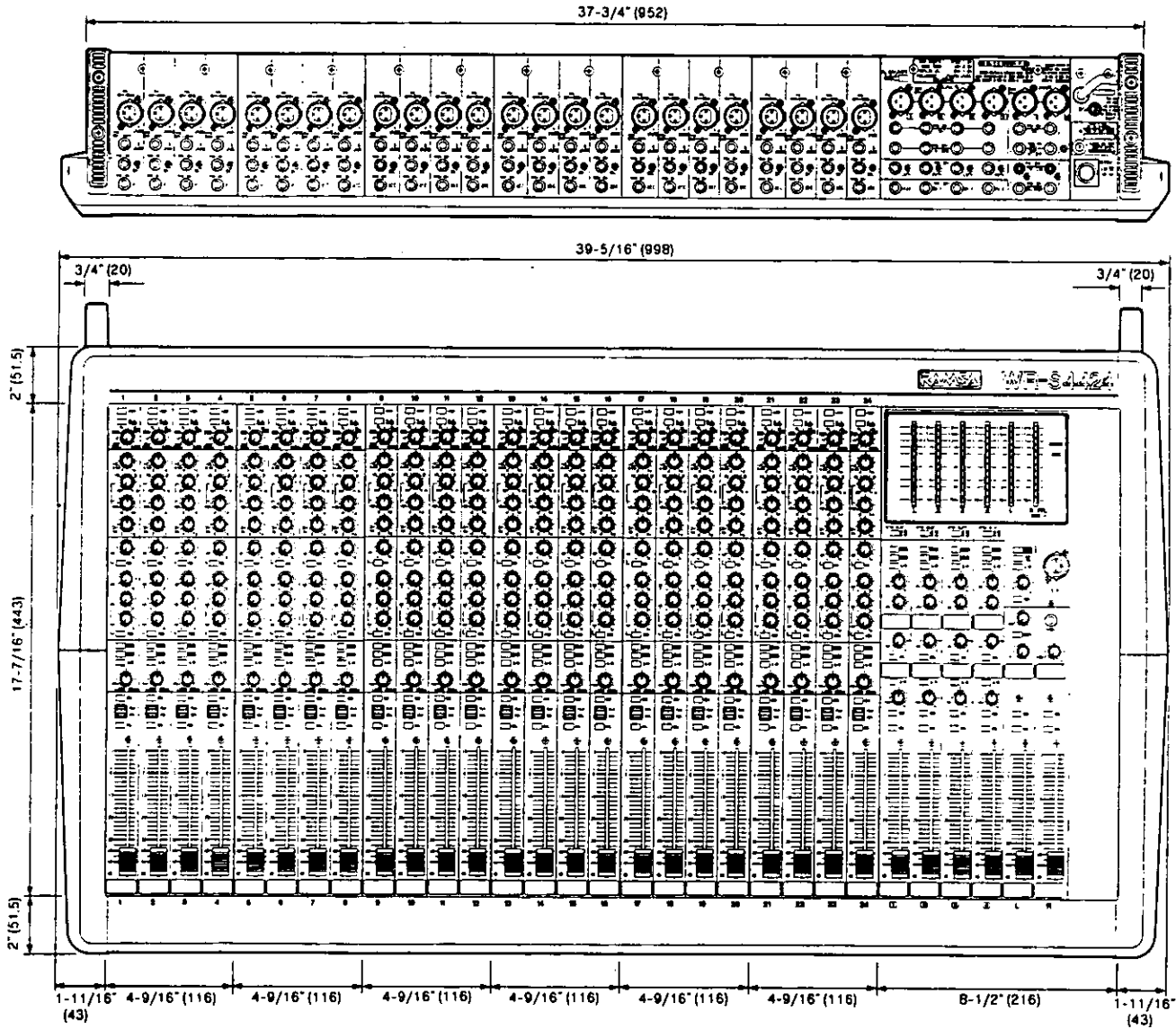

TECHNICAL SPECIFICATIONS

	Standard	Measurement Condition
Frequency Response	+1/-2.5dB at 20Hz~20kHz	Input "A" to Group Out, +4dB IN, +4dB OUT, RL=600Ω, Norminal Setting
T. H. D.	< 0.1% at 20Hz to 20kHz	Input "A" to Group Out, +4dB IN, +4dB OUT, RL=600Ω, Norminal Setting
Equivalent Input Noise	< -126dB at 150Ω Input Source Impedance	Audio Band Pass Filter W. T. D. Mono IN "A" to Group Out
Maximum Voltage Gain	94 +2/-2dB at 1kHz	Mono input "A" to Group to Master Out RL=10kΩ
Crosstalk	< -70dB at 1kHz Adjacent Input Channels & CH SW & Fader	Input "A" to Group Out, +4dB IN, +4dB OUT, RL=10kΩ, Norminal Setting
C. M. R. R.	< -80dB at 1kHz	Input "A" to Group Out, Trim at "-60dB"
Mono Input Equalizer Low Mid. High	Fixed shelving type: 70Hz, ±15 ±3dB Sweepable peaking type: 200Hz to 6.3kHz, ±15 ±3dB Fixed shelving type: 12.5kHz, ±15 ±3dB (High/Low by Frequency Regulation of Shelving ±12 ±2.5dB)	Input "A" to Group Out, +4dB IN, +4dB OUT, RL=10kΩ, Norminal Setting Each EQ gain "PEAK" or "DIP"
Maximum Input Level	Input A +22dB +3/-0dB Input B +28dB +3/-0dB	Trim at CCW
Maximum Output Level	+24dB +2/-0dB (Group/Master Out Balanced) at 1kHz +20dB +2/-0dB (Aux/Monitor Out Unbalanced) at 1kHz	Input "A", OUT FADER "MAX", +4dB in +14dB out Setting RL=600Ω (GROUP, MASTER, AUX), RL=10kΩ (MONITOR)
Residual Output Noise	< -90dB by Group, Aux, Master, Monitor Output	Output Faders & Level Control at "KILL", RL=600Ω (EX, 10kΩ : Monitor) Audio Band Pass Filter W. T. D.
Fader	100mm Stroke High Precision Carbon Fader	
Meter	VU Response 12 Segment 3 Color LED Bar-graph Meter	
Power Supply	120V AC, 50/60Hz	
Power Consumption WR-S4412 WR-S4416 WR-S4424	55W 60W 70W	
Dimensions (W x H x D) WR-S4412 WR-S4416 WR-S4424	12ch 25-9/16" x 6-3/4" x 23" (650mm x 171mm x 584mm) 16ch 30-3/16" x 6-3/4" x 23" (766mm x 171mm x 584mm) 24ch 39-5/16" x 6-3/4" x 23" (998mm x 171mm x 584mm)	
Net Weight WR-S4412 WR-S4416 WR-S4424	12ch 40.7 lbs. (18.5kg) 16ch 46.2 lbs. (21.0kg) 24ch 60.5 lbs. (27.5kg)	

* 0dB=0.775 vrms

INPUT SPECIFICATION

Input Characteristics	Indicated Impedance	Nominal Source Impedance	Nominal Load Impedance	Nominal Level	Maximum Level	Connector
Mono Input A	5k Ω	150 - 600		-60 - +4dB	-38 - +22dB	Electronically-Balanced XLR
Mono Input B	10k Ω	150 - 600		-54 - +10dB	-32 - +28dB	Same above, T/R/S phone
Input/Output Insertion Return	10k	600		-2dB	+20	Unbalanced, T/R/S phone
Sub Input	10k	600		+4	+26	Unbalanced, T/R/S or T/S phone
Aux Return	10k	600		+4	+26	Unbalanced, T/R/S phone
Talk Back	5k	150 - 600		-50 - -20	-28 - +2	Unbalanced, XLR

OUTPUT SPECIFICATIONS

Output Characteristics	Indicated Impedance	Nominal Source Impedance	Nominal Load Impedance	Nominal Level	Maximum Level	Connector
Group, Master Output	600		600	+4	+24	Electronically-Balanced, XLR
Aux Output	600		600	+4	+20	Unbalanced, T/R/S or T/S phone
Input/Output Insertion Send	10k		10k	-2	+20	Unbalanced, T/R/S phone
Direct Output	10k		10k	-2	+20	Unbalanced, T/R/S or T/S phone
Monitor Output	10k		10k	+4	+20	Same above
Rec Output	10k		10k	-10	+12	Unbalanced, RCA pin
Headphone Output	400		400	-	160mW	Unbalanced, T/R/S phone

Panasonic®

**Panasonic Communications &
Systems Company**
Audio-video System Group
Professional Audio Division
6550 Katella Ave, Cypress, Ca 90630
(714) 373-7200

**Matsushita Electric of
Canada Limited**
Industrial Audio Department
5770 Ambler Drive, Mississauga,
Ontario, L4W 2T3
(416) 624-5010

**Panasonic Sales Company,
Division of Matsushita Electric
of Puerto Rico, Inc.**
San Gabriel Industrial Park,
65th Infantry, Ave KM 9 5
Carolina, Puerto Rico 00630
(809) 750-4300

N0891-0 YWA8QA2540AN

© Matsushita Electric Industrial Co. Ltd.,
All rights reserved. Unauthorized
copying and distribution is a violation of law.

Ⓝ 13